

DESCRIPTION:

The products are 1MBd high-speed opto-couplers. The device is a small-outline coupler suitable for surface-mount assembly. It consists of a high-output-power infrared LED optically coupled to a high-speed photodiode-transistor chip. It is housed in a plastic WSOP8 and guarantees a creepage distance of ≥ 5 mm, a clearance of ≥ 5 mm and an insulation thickness of ≥ 0.4 mm. Therefore, it meets the reinforced insulation class requirements of international safety standards. The products are widely used in programmable controllers, industrial inverters and switching power supplies.



MAIN FEATURES

High isolation 7500 VRMS

CTI ≥ 600

Operating temperature range -40°C to 110°C

REACH & RoHS compliance

HBM: H3A; MM: M4; CDM: C3

CQC approved

VDE approved

UL approved

Truth Table

LED	Output
ON	L
OFF	H

ABSOLUTE MAXIMUM RATINGS (Temperature= 25°C)

Parameter		Symbol	Value	Unit
Input	Forward Current	I_F	50	mA
	Peak Forward Current	I_{FP}	1 ^①	A
	Reverse Voltage	V_R	6	V
	Input Power Dissipation	P_D	100	mW
Output	Supply Voltage	V_{CC}	35	V
	Output Voltage	V_O	20	V

	Output Current	I_o	8	mA
	Output Power Dissipation	P_o	100	mW
Total Power Dissipation		P_{tot}	200	mW
Isolation Voltage		V_{iso}	7500 ^②	V _{rms}
Operating Temperature		T_{opr}	-40~110	°C
Junction Temperature		T_j	125	°C
Storage Temperature		T_{stg}	-55~125	°C
Soldering Temperature		T_{sol}	260	°C

NOTE1 : 100μs pulse, 100Hz frequency

NOTE2 : AC for 1minute, R.H.=40~60%

ELECTRICAL CHARACTERISTICS (Temperature=25°C)

Parameter		Symbol	Condition	Min.	Typ.	Max.	Unit
Input	Forward Voltage	V_F	$I_F=10mA$	-	1.35	1.6	V
	Reverse Current	I_R	$V_R=6V$	-	-	1	μA
	Input Capacitance	C_{in}	$V=0, f=1MHz$	-	60	-	pF
Output	Current transfer ratio	CTR	$I_F=16mA, V_{CC}=4.5V, V_O=0.4V$	20	-	60	%
	High Level Output Current	I_{OH}	$I_F=0mA, V_{CC}=5.5V, V_O=5.5V$	-	3	500	nA
			$I_F=0mA, V_{CC}=15V, V_O=15V$	-	-	50	μA
	Low Level Supply Current	I_{CCL}	$V_O=Open, V_{CC}=15V, I_F=16mA$	-	0.5	0.8	mA
	High Level Supply Current	I_{CCH}	$V_O=Open, V_{CC}=15V, I_F=0mA$	-	0.01	2	μA
	Logic Low Output Voltage	V_{OL}	$I_F=16mA, I_o=2.4mA, V_{CC}=4.5V$	-	-	0.4	V
	Isolation Resistance	R_{iso}	DC500V 40~60%R.H.	10^{12}	10^{14}	-	Ω
	Floating Capacitance	C_{io}	$V=0, f=1MHz$	-	0.8	-	pF
Switching Characteristics	Propagation Delay Time to Logic Low	TPHL	$I_F=0 \rightarrow 16mA, R_L=1.9k\Omega, V_{CC}=5V$	-	-	0.8	μs
	Propagation Delay Time to Logic High	TPLH	$I_F=16 \rightarrow 0mA, R_L=1.9k\Omega, V_{CC}=5V$	-	-	0.8	μs

	Common Mode Transient Immunity at Logic High	CM _H	I _F =0mA, V _{CM} =400Vpp, R _L =4.1kΩ	15	20	-	kV/μs
	Common Mode Transient Immunity at Logic Low	CM _L	I _F =16mA, V _{CM} =400Vpp, R _L =4.1kΩ	-15	-20	-	kV/μs

ORDERING INFORMATION

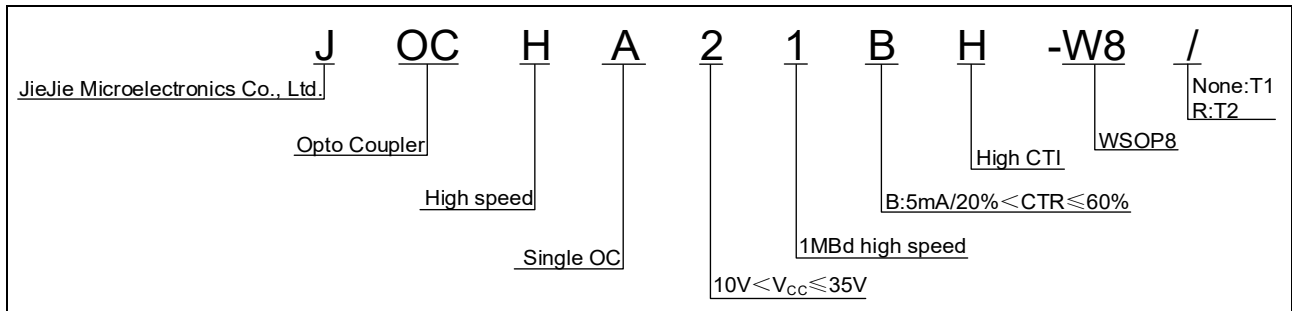

Packing Quantity			
Option	Quantity	Quantity – Inner box	Quantity –Outer box
WSOP8	1200 Units/Reel	1 Reel/Inner box	5 Inner box/Outer box =6k Units

MARKING

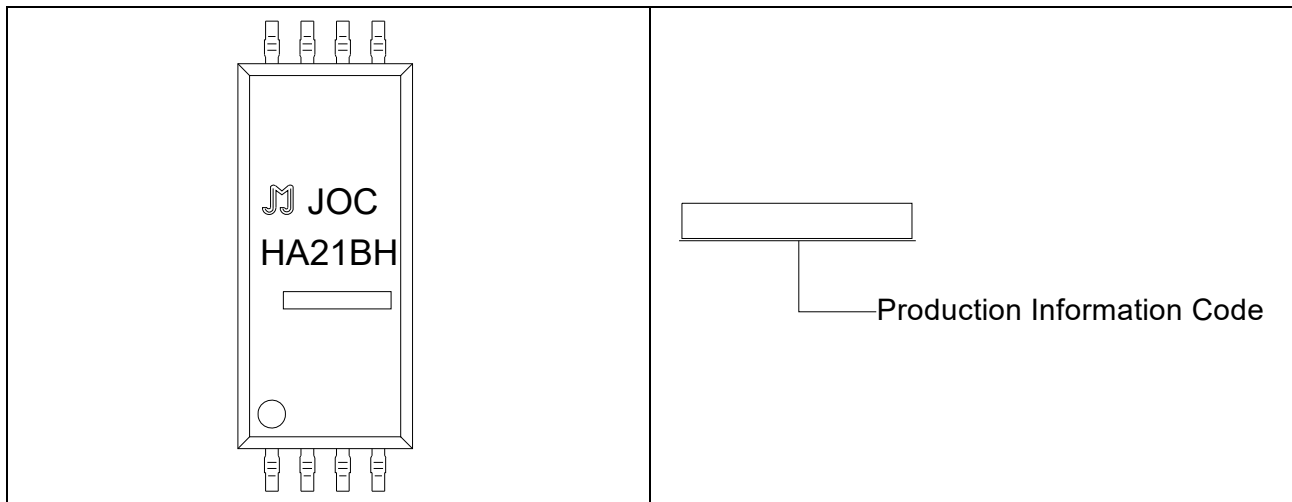

Characteristics Curves

FIG.1: Forward Current vs. Forward Voltage

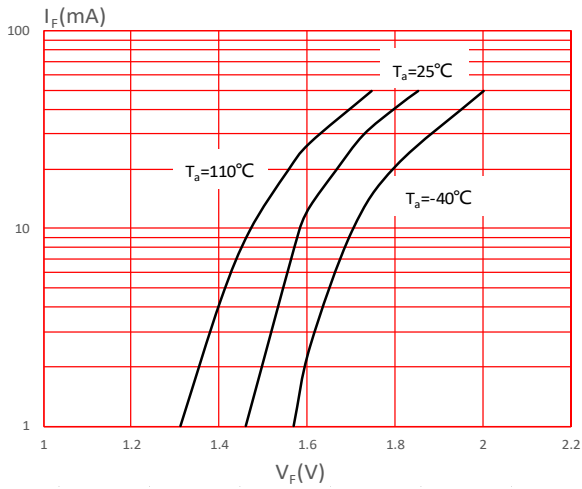

FIG.2: High Level Output Current vs. Ambient Temperature

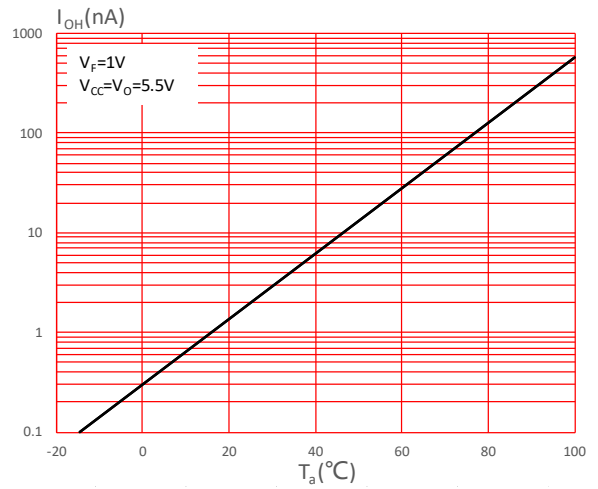

FIG.3: Output Current vs. Forward Current

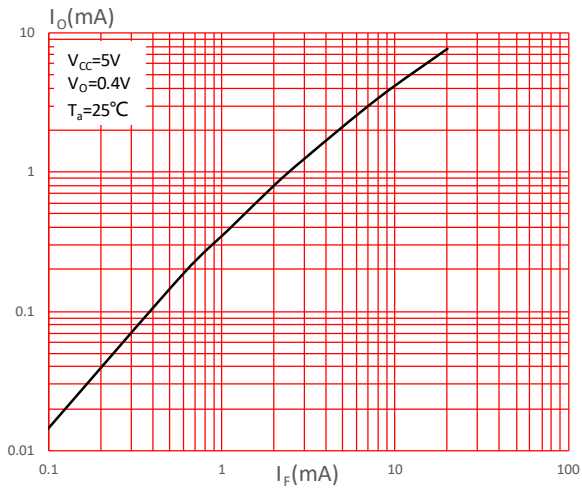

FIG.4: Current Transfer Ratio vs. Forward Current

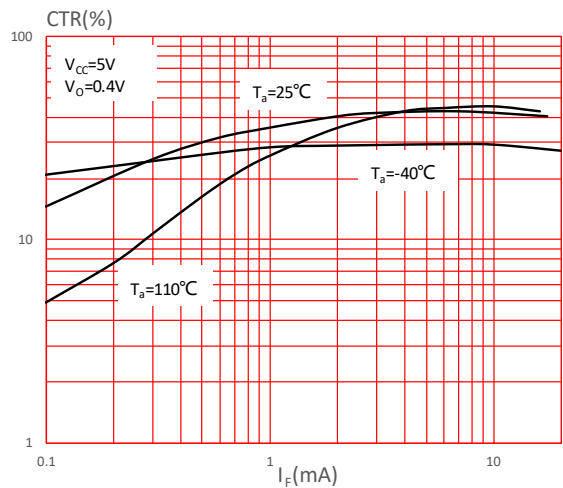

FIG.5: Normalized Current Transfer Ratio vs. Ambient Temperature

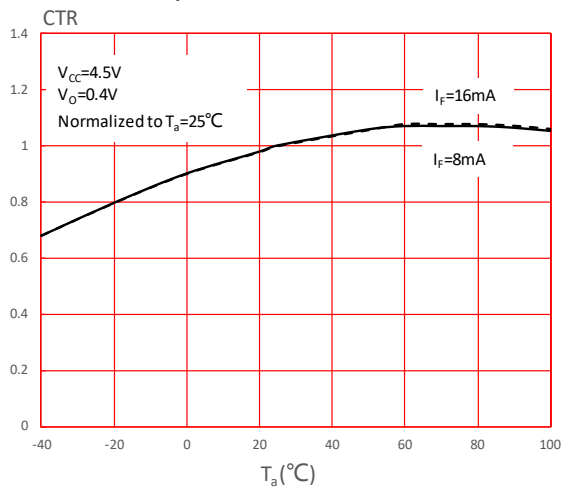

FIG.6: Output Current vs. Output Voltage

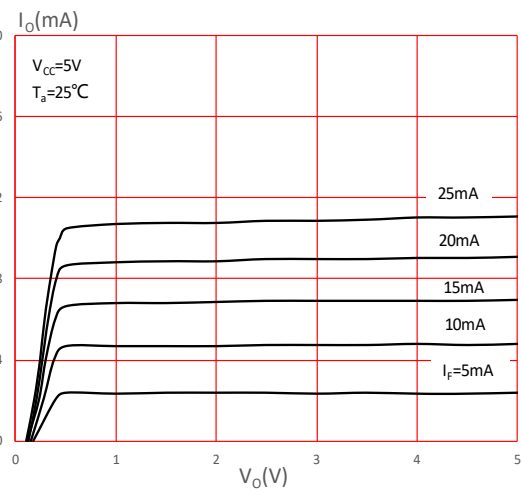

FIG.7: Low Level Output Voltage vs. Ambient Temperature

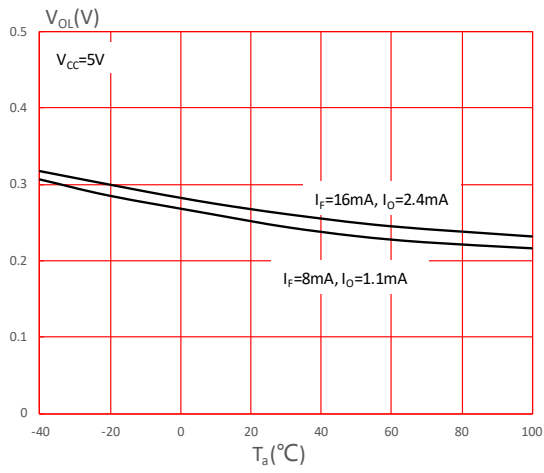

FIG.8: Propagation Delay vs. Load Resistance

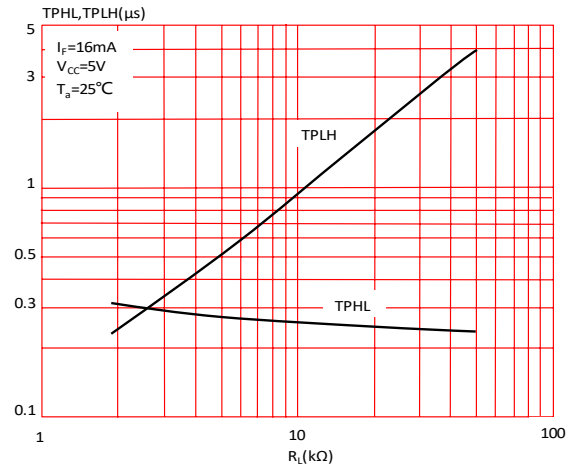
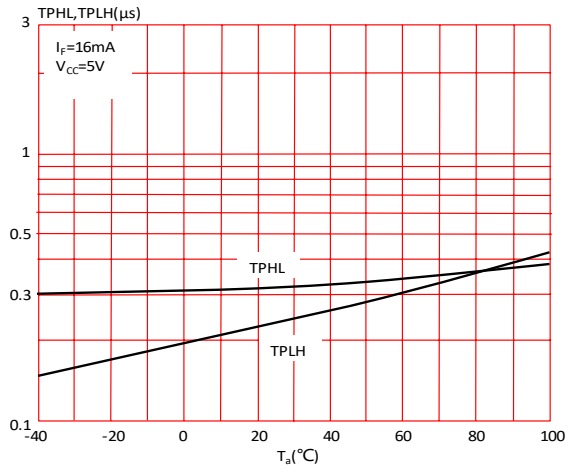

FIG.9: Propagation Delay vs. Ambient Temperature



TEST CIRCUITS

Fig.10: Test Circuit of tPHL, tPLH

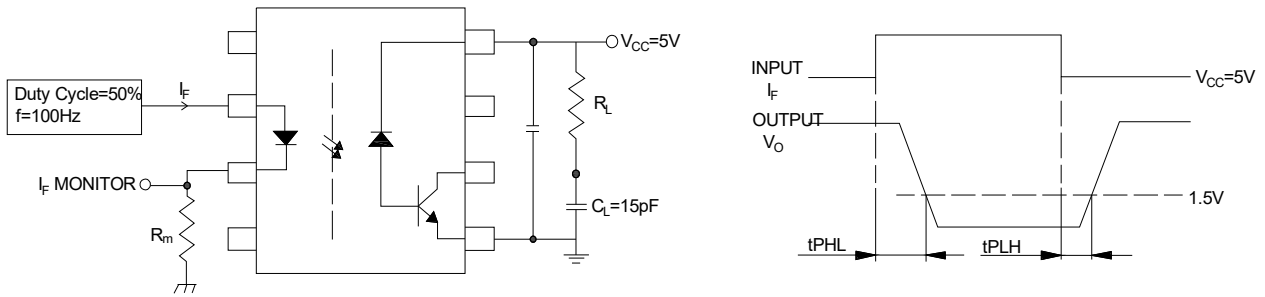
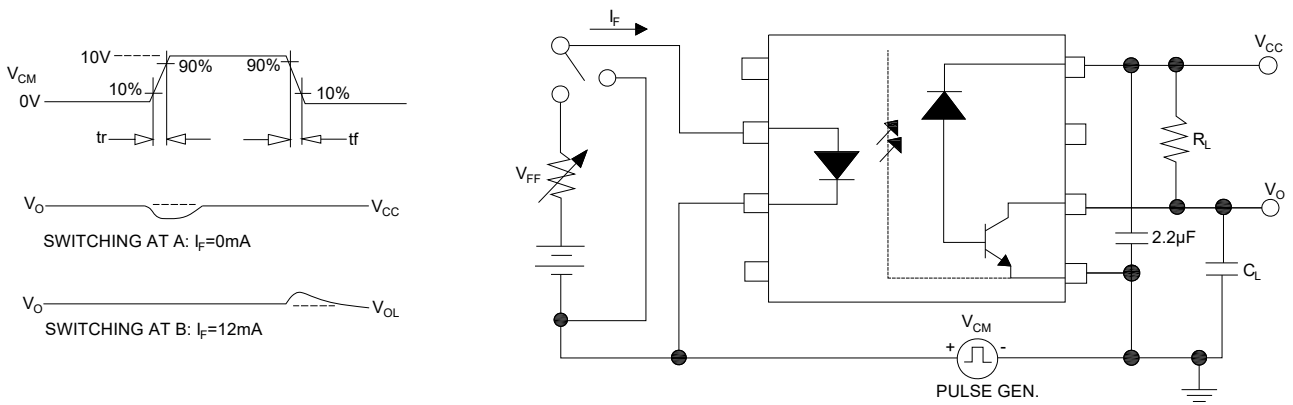

Fig.11: Test Circuit for Transient Immunity and Typical Waveforms



Package Dimension (Unit: mm)



Ref.	Dimensions					
	Millimeters			Inches		
	Min.	Typ.	Max.	Min.	Typ.	Max.
A	13.50		13.70	0.531		0.539
B	6.15		6.35	0.242		0.250
C	0.10		0.30	0.004		0.012
D	3.50		3.70	0.138		0.146
E	14.71		15.31	0.579		0.603
F	0.52		1.02	0.020		0.040
G	16.36		16.86	0.644		0.664
H	0.10		0.40	0.004		0.016
I	3.65		3.95	0.144		0.156
J	0.307		0.607	0.012		0.024
K	1.02		1.52	0.040		0.060

RECOMMENDED SOLDER MASK (Dimensions in mm unless otherwise stated)

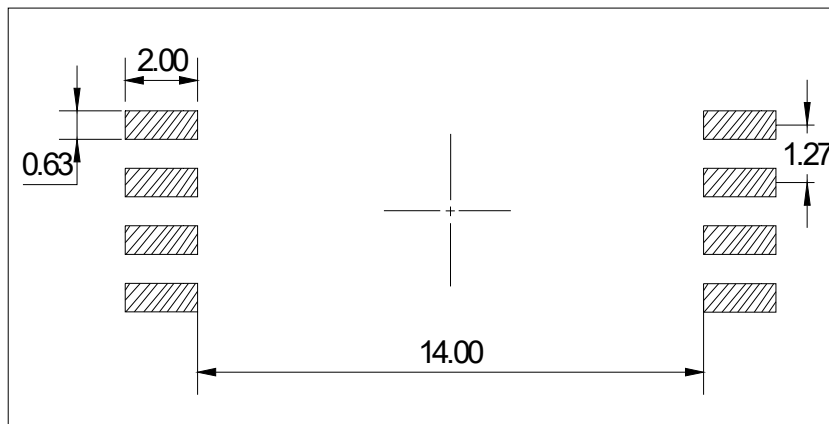

CARRIER TAPE SPECIFICATIONS (Dimensions in mm unless otherwise stated)

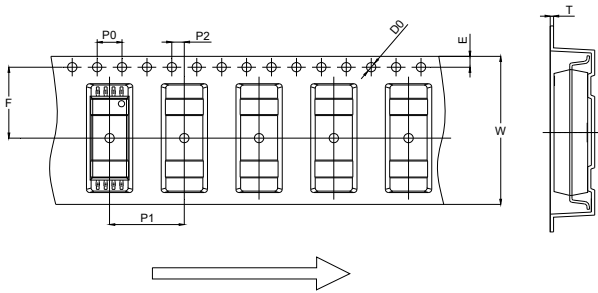

Ref.	Dimensions					
	Millimeters			Inches		
	Min.	Typ.	Max.	Min.	Typ.	Max.
D0	1.40	1.50	1.60	0.055	0.059	0.063
P0	3.90	4.00	4.10	0.154	0.157	0.161
P1	11.90	12.00	12.10	0.469	0.472	0.476
P2	1.90	2.00	2.10	0.075	0.079	0.083
E	1.65	1.75	1.85	0.065	0.069	0.073
F	11.40	11.50	11.60	0.449	0.453	0.457
T	0.35	0.40	0.45	0.014	0.016	0.018
W	23.70	24.00	24.30	0.933	0.945	0.957

REFLOW INFORMATION

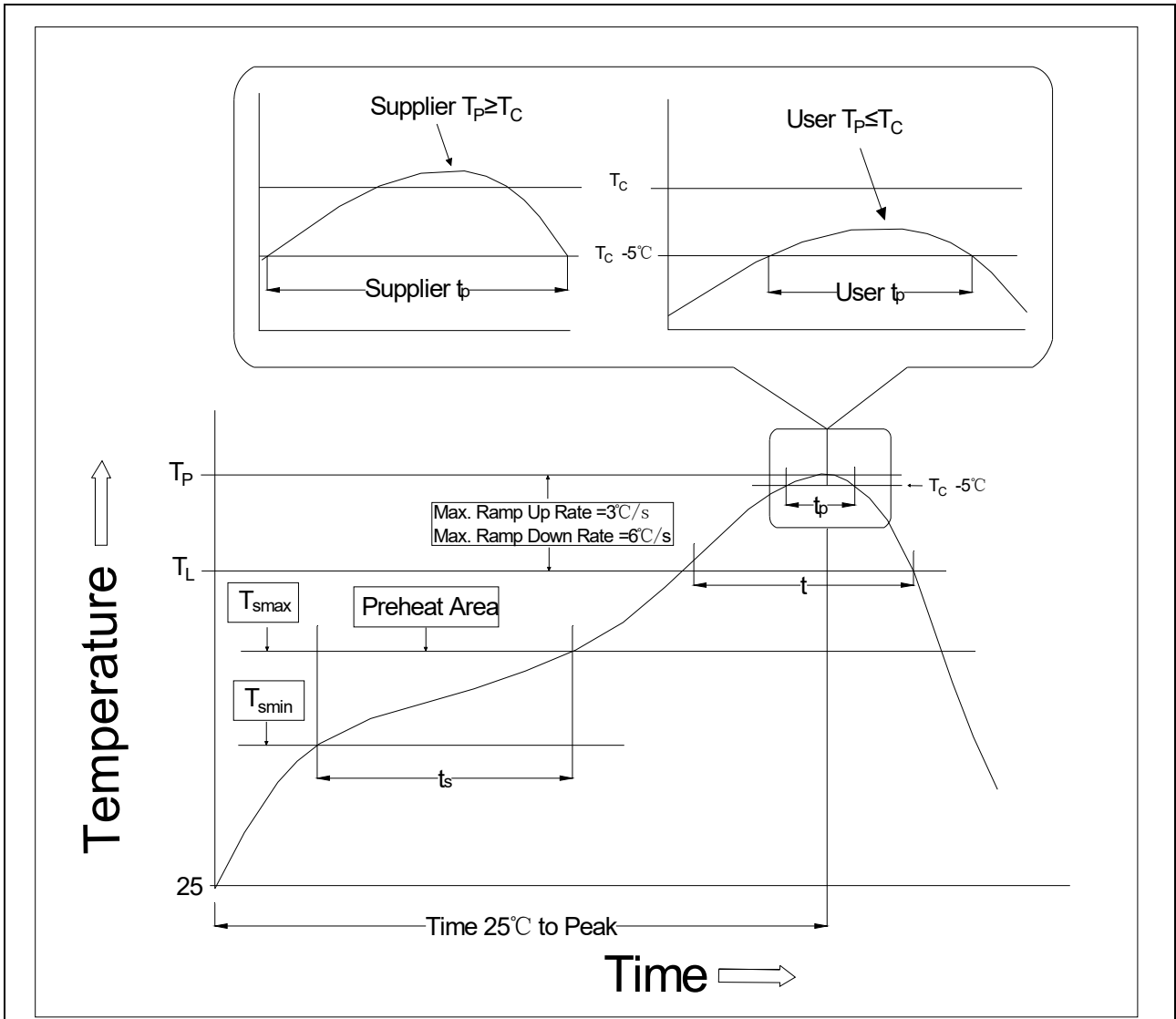

Profile Feature	Sn-Pb Assembly Profile	Pb-Free Assembly Profile
Temperature Min. (T _{smin})	100°C	150°C
Temperature Max. (T _{smax})	150°C	200°C
Time (t _s) from (T _{smin} to T _{smax})	60-120 seconds	60-120 seconds
Ramp-up Rate (t _L to t _P)	3°C/second max.	3°C/second max.
Liquidus Temperature (T _L)	183°C	217°C
Time (t _L) Maintained Above (T _L)	60-150 seconds	60-150 seconds
Peak Body Package Temperature	235°C+0°C/-5°C	260°C+0°C/-5°C
Time (t _P) within 5°C of 260°C	10 seconds	10 seconds
Ramp-down Rate (T _P to T _L)	3-6°C/second	3-6°C/second
Time 25°C to Peak Temperature	6 minutes max.	8 minutes max.

Note:

1. Reflow soldering is recommended at the temperatures and times shown, no more than three times.
2. Avoid direct contact between the epoxy body and any tools or surfaces exceeding its maximum storage temperature.
3. Application of pressure on the epoxy body is prohibited at elevated temperatures. In specific scenarios, any applied force must not exceed 2.5N.
4. Ensure the component has cooled to ambient temperature before proceeding with any subsequent manufacturing steps.
5. The component has a shelf life of one year when stored under standard conditions.
6. Recommend storage Temp.: 0~40°C;
Recommend storage humidity: <60%;
MSL level: MSL 1

Information furnished in this document is believed to be accurate and reliable. However, Jiangsu JieJie Microelectronics Co., Ltd. assumes no responsibility for the consequences of use without consideration for such information nor use beyond it. Information mentioned in this document is subject to change without notice, apart from that when an agreement is signed, Jiangsu JieJie complies with the agreement.

Products and information provided in this document have no infringement of patents. Jiangsu JieJie assumes no responsibility for any infringement of other rights of third parties which may result from the use of such products and information. This document supersedes and replaces all information previously supplied.

 is a registered trademark of Jiangsu JieJie Microelectronics Co., Ltd.

Copyright © 2026 Jiangsu JieJie Microelectronics Co., Ltd. All rights reserved.