



JOCHA14B-M5

Rev.A.1.0

DESCRIPTION:

The products are 10MBd high-speed opto-couplers in the SOP5 package. The device consists of a high efficient AlGaAs Light Emitting Diode and a high speed optical detector. This design provides excellent AC and DC isolation between the input and output sides of the optocoupler. The output of the optical detector features an open collector Schottky clamped transistor. The enable function allows the optical detector to be strobed. A guaranteed common mode transient immunity is up to 10kV/ μ s at 3.3V. The optocoupler operational parameters are guaranteed over the temperature range from -40°C ~ +110°C. The products are widely used in isolation in line receivers, digital isolation for A/D,D/A conversion, ground loop elimination, feedback element in switching mode power supplier, pulse transformer replacement, power transistor isolation in motor drives, interface between microprocessor system, computer and their peripheral.

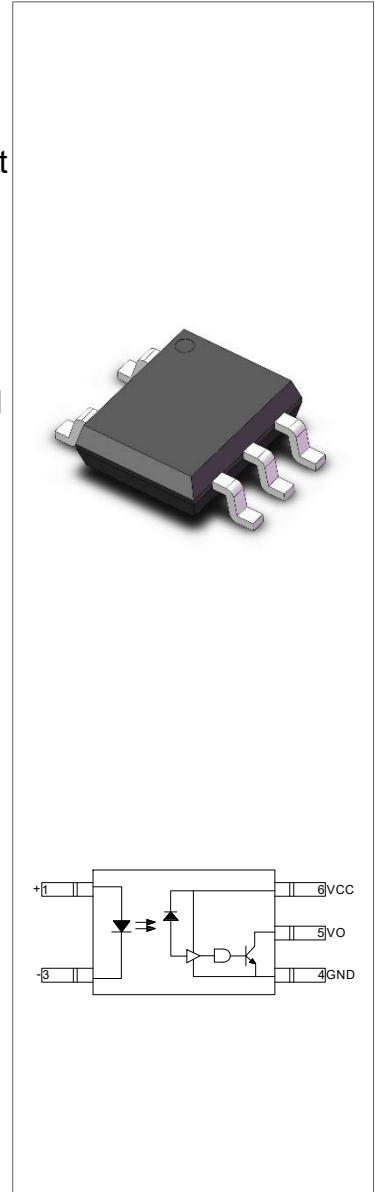

MAIN FEATURES

- High isolation 3750 VRMS
- High speed – 10MBd typical
- Operating temperature range -40°C to 110°C
- REACH & RoHS compliance
- HBM: H3A; MM: M4; CDM: C3
- CQC approved
- VDE approved
- UL approved

Truth Table

INPUT	OUTPUT
H	L
L	H

ABSOLUTE MAXIMUM RATINGS (Temperature=25°C)

Parameter		Symbol	Value	Unit
Input	Forward Current	I_F	50	mA
	Peak Forward Current	I_{FP}	1 ^①	A
	Reverse Voltage	V_R	6	V
	Input Power Dissipation	P_D	100	mW
Output	Supply Voltage	V_{CC}	7	V
	Output Voltage	V_O	7	V
	Output Current	I_O	50	mA
	Output Power Dissipation	P_O	85	mW
Total Power Dissipation		P_{tot}	200	mW
Isolation Voltage		V_{iso}	3750 ^②	Vrms
Operating Temperature		T_{opr}	-40~110	°C
Junction Temperature		T_j	125	°C
Storage Temperature		T_{stg}	-55~125	°C
Soldering Temperature		T_{sol}	260	°C

NOTE1: 100μs pulse, 100Hz frequency

NOTE2: AC for 1minute, R.H.=40~60%

ELECTRICAL CHARACTERISTICS (Temperature=25°C)

Parameter		Symbol	Condition	Min.	Typ.	Max.	Unit
Input	Forward Voltage	V_F	$I_F=10mA$	-	1.35	1.6	V
	Reverse Current	I_R	$V_R=6V$	-	-	1	μA
	Input Capacitance	C_{in}	$V=0, f=1MHz$	-	34	-	pF
Output	High Level Output Current	I_{OH}	$I_F=250\mu A,$ $V_{CC}=3.3V,$ $V_O=3.3V$	-	5	100	μA
	High Level Supply Current	I_{CCH}	$V_{CC}=3.3V,$ $I_F=0mA$	-	-	10	μA
	Low Level Supply Current	I_{CCL}	$V_{CC}=3.3V,$ $I_F=10mA$	-	-	13	mA
	Logic Low Output Voltage	V_{OL}	$I_F=5mA,$ $I_O=13mA,$ $V_{CC}=3.3V$	-	0.3	0.6	V

	Isolation Resistance	R_{ISO}	DC500V 40~60%R.H.	-	10^{12}	-	Ω
	Floating Capacitance	C_{IO}	V=0, f=1MHz	-	1	-	pF
Switching Characteristics	Trigger LED Current	I_{FT}	$V_{CC}=5V,$ $V_O=V_{OL}$	-	-	5	mA
	Propagation Delay Time to Logic Low	t_{PHL}	$C_L=15pF,$ $R_L=350\Omega,$ $I_F=7.5mA$	-	-	60	ns
	Propagation Delay Time to Logic High	t_{PLH}		-	-	60	ns
	Pulse width distortion	$ t_{PHL}-t_{PLH} $		-	-	35	ns
	Common Mode Transient Immunity at Logic High	CM_H	$V_{CC}=3.3V,$ $I_F=0mA,$ $V_{CM}=1000V,$ $R_L=350\Omega$	10	15	-	kV/ μ s
	Common Mode Transient Immunity at Logic Low	CM_L	$V_{CC}=3.3V,$ $I_F=10mA,$ $V_{CM}=1000V,$ $R_L=350\Omega$	10	15	-	kV/ μ s
	Rise Time	t_r	$C_L=15pF,$ $R_L=350\Omega,$ $I_F=7.5mA$	-	30	-	ns
Fall Time	t_f	-		30	-	ns	

Recommended Operating Conditions

Characteristics	Symbol	Min.	Typ.	Max.	Unit
Operating Temperature	T_a	-40	-	85	$^{\circ}C$
Supply Voltage	V_{CC}	2.7	-	3.6	V
		4.5	-	5.5	
Low Level Input Current	I_{FL}	0	-	250	μA
High Level Input Current	I_{FH}	7	-	15	mA

Output Pull-up Resistor	R _L	330	-	4k	Ω
Fan Out (at R _L =1kΩ per channel)	N	-	-	5	TTL Loads

ORDERING INFORMATION

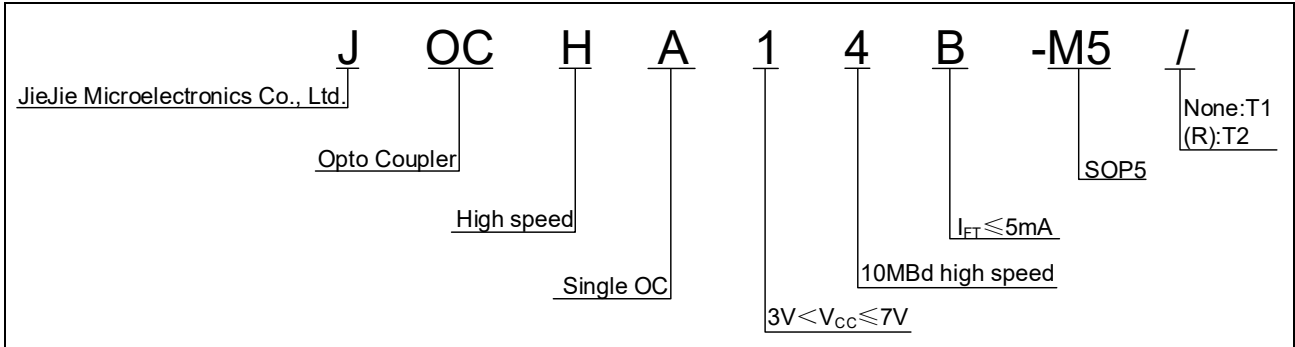

Packing Quantity			
Option	Quantity	Quantity – Inner box	Quantity –Outer box
SOP5	3000 Units/Reel	2 Reels/Inner box	5 Inner box/Outer box =30k Units

MARKING

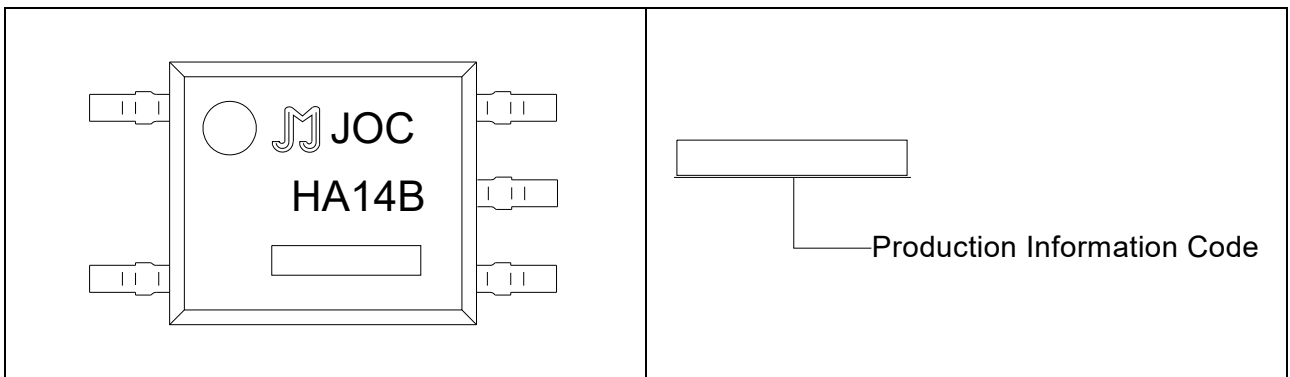

Characteristics Curves

FIG.1: High Level Output Current vs. Ambient Temperature

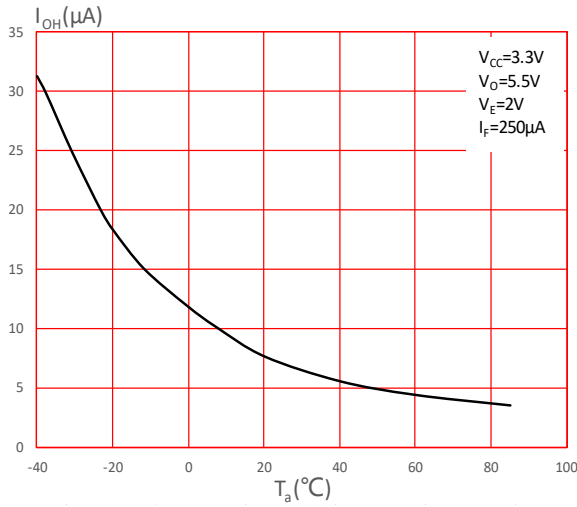

FIG.2: High Level Output Current vs. Ambient Temperature

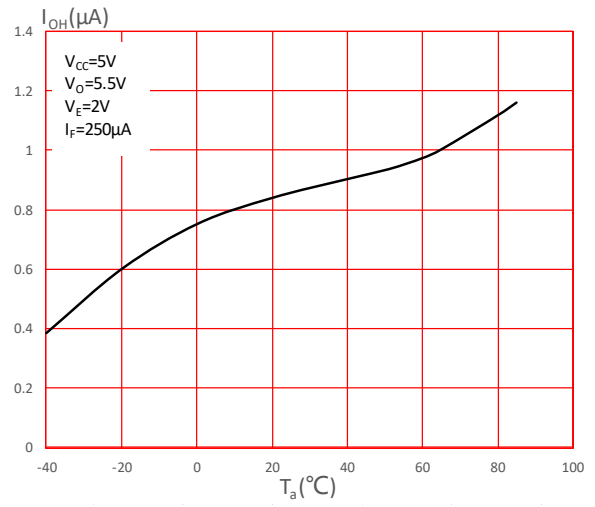

FIG.3: Input Threshold Current vs. Ambient Temperature

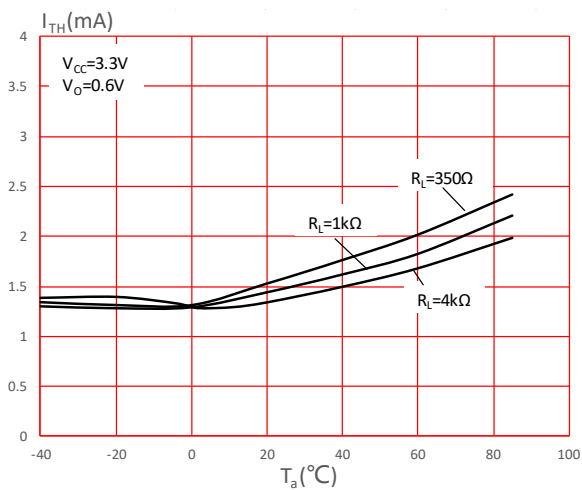

FIG.4: Input Threshold Current vs. Ambient Temperature

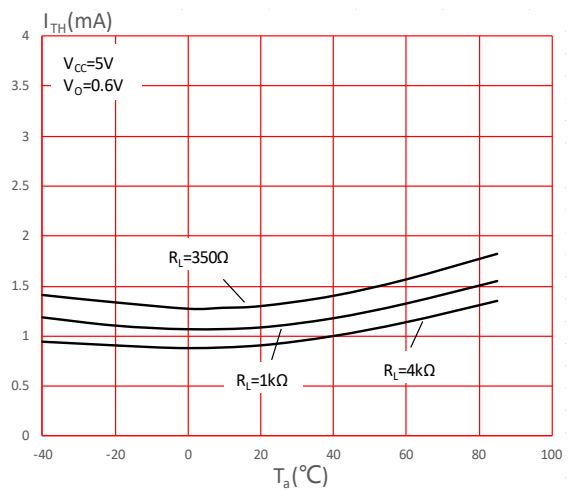

FIG.5: Low Level Output Voltage vs. Ambient Temperature

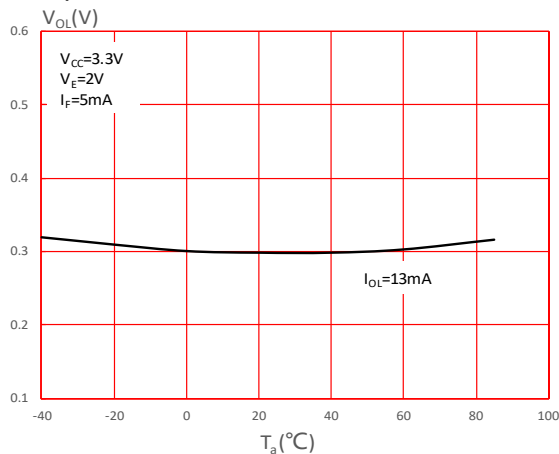

FIG.6: Low Level Output Voltage vs. Ambient Temperature

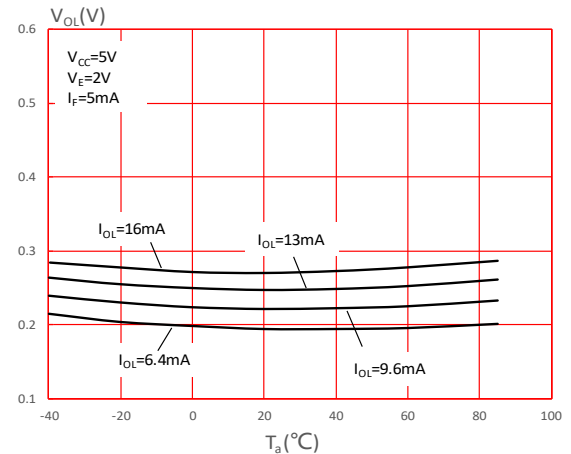

FIG.7: Low Level Output Current vs. Ambient Temperature

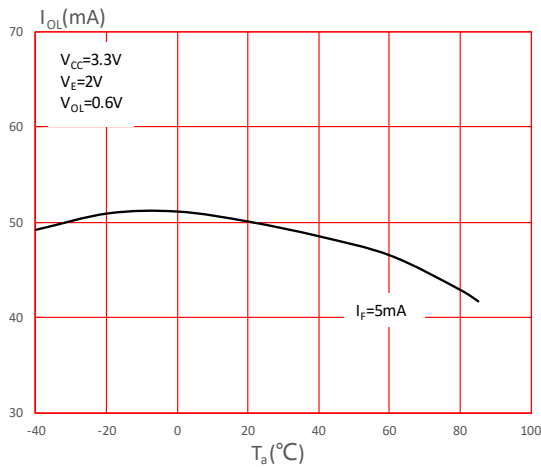

FIG.8: Low Level Output Current vs. Ambient Temperature

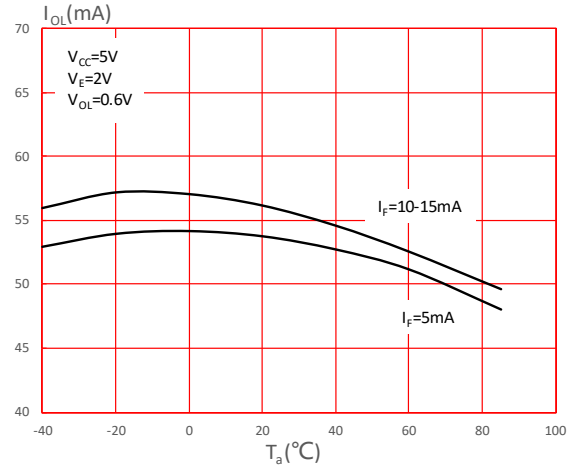

FIG.9: Input Forward Voltage vs. Input Forward Current

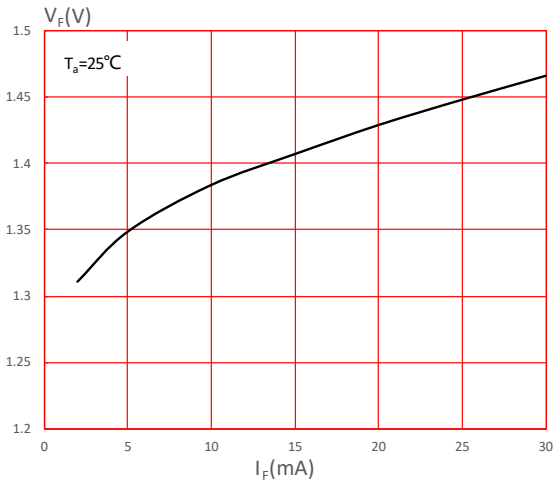

FIG.10: Forward Voltage vs. Ambient Temperature

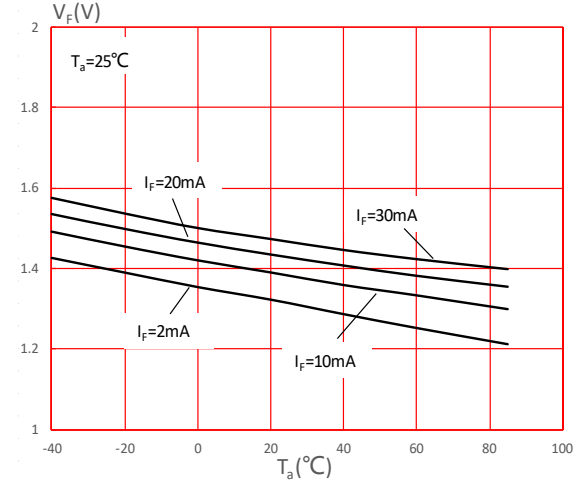

FIG.11: Propagation Delay vs. Ambient Temperature

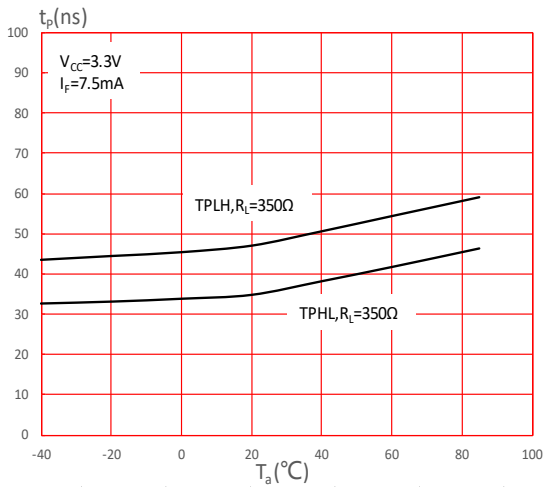

FIG.12: Propagation Delay vs. Ambient Temperature

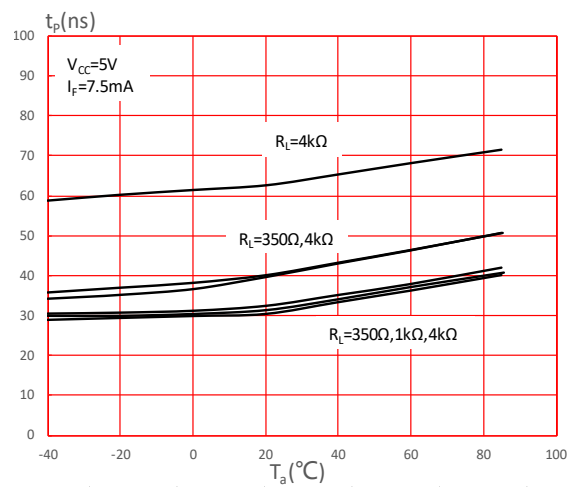

FIG.13: Pulse Width Distortion vs. Ambient Temperature

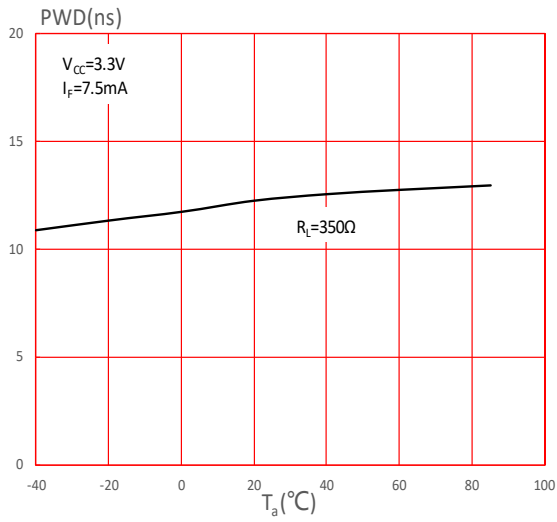
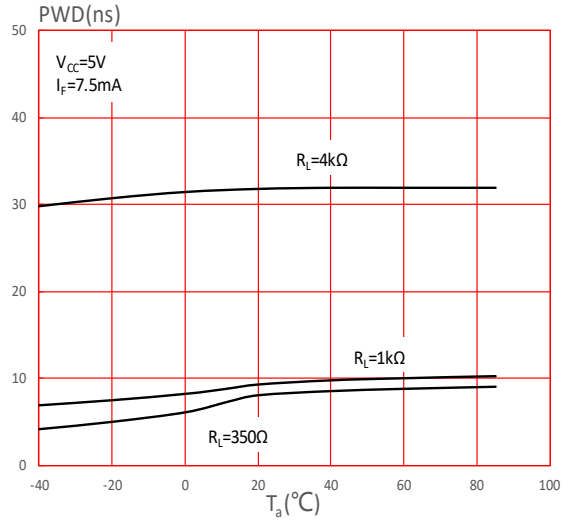
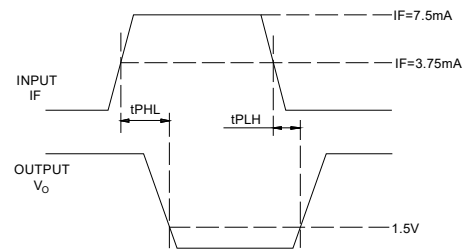
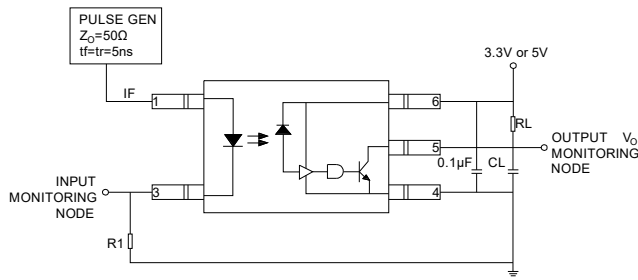

FIG.14: Pulse Width Distortion vs. Ambient Temperature



TEST CIRCUITS

Fig.15: Test Circuit and Waveform of tPHL, tPLH



Package Dimension (Unit: mm)

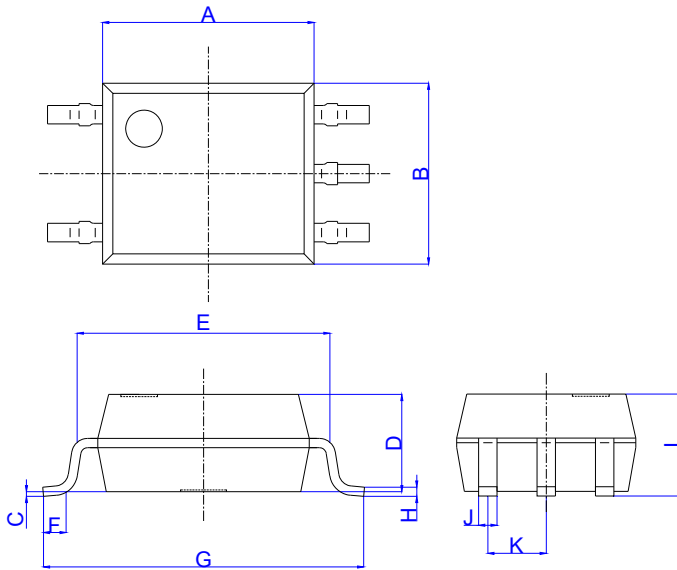

Ref.	Dimensions					
	Millimeters			Inches		
	Min.	Typ.	Max.	Min.	Typ.	Max.
A	4.40		4.80	0.173		0.189
B	3.60		4.20	0.142		0.165
C	0.00		0.20	0.000		0.008
D	1.90		2.30	0.075		0.091
E	5.00		5.60	0.197		0.220
F	0.34		0.94	0.013		0.037
G	6.70		7.30	0.264		0.287
H	0.10		0.30	0.004		0.012
I	2.00		2.40	0.079		0.094
J	0.25		0.55	0.010		0.022
K	1.02		1.52	0.040		0.060

RECOMMENDED SOLDER MASK (Dimensions in mm unless otherwise stated)

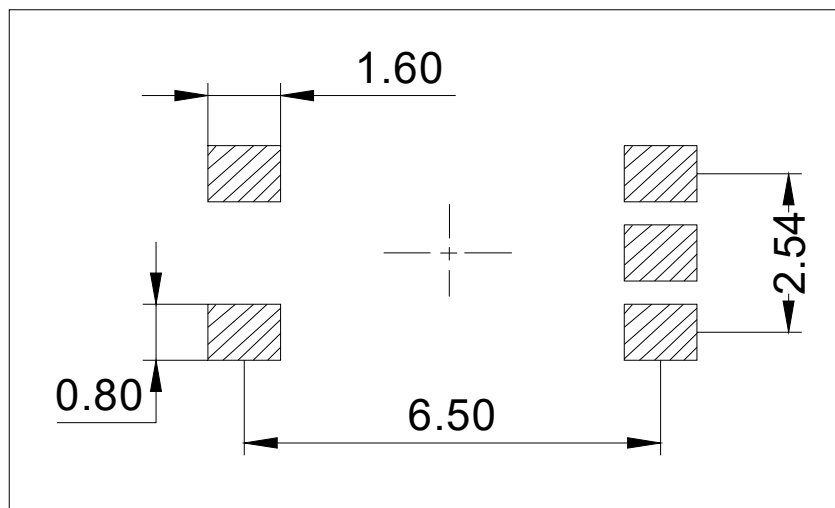

CARRIER TAPE SPECIFICATIONS (Dimensions in mm unless otherwise stated)

Option None

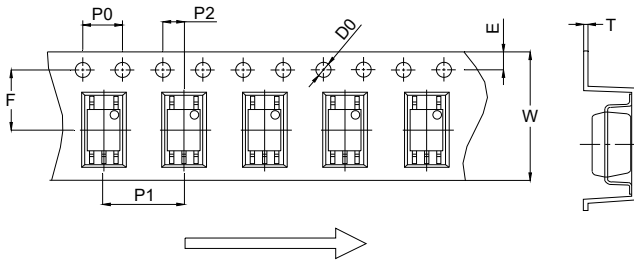

Ref.	Dimensions					
	Millimeters			Inches		
	Min.	Typ.	Max.	Min.	Typ.	Max.
D0		1.50	1.60		0.059	0.063
P0	3.90	4.00	4.10	0.154	0.157	0.161
P1	7.90	8.00	8.10	0.311	0.315	0.319
P2	1.90	2.00	2.10	0.075	0.079	0.083
E	1.65	1.75	1.85	0.065	0.069	0.073
F	4.40	4.50	4.60	0.173	0.177	0.181
T	0.25	0.30	0.35	0.010	0.012	0.014
W	11.90	12.00	12.30	0.469	0.472	0.484

Option R

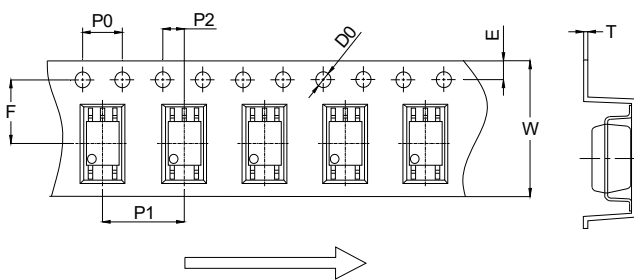

Ref.	Dimensions					
	Millimeters			Inches		
	Min.	Typ.	Max.	Min.	Typ.	Max.
D0		1.50	1.60		0.059	0.063
P0	3.90	4.00	4.10	0.154	0.157	0.161
P1	7.90	8.00	8.10	0.311	0.315	0.319
P2	1.90	2.00	2.10	0.075	0.079	0.083
E	1.65	1.75	1.85	0.065	0.069	0.073
F	4.40	4.50	4.60	0.173	0.177	0.181
T	0.25	0.30	0.35	0.010	0.012	0.014
W	11.90	12.00	12.30	0.469	0.472	0.484

REFLOW INFORMATION

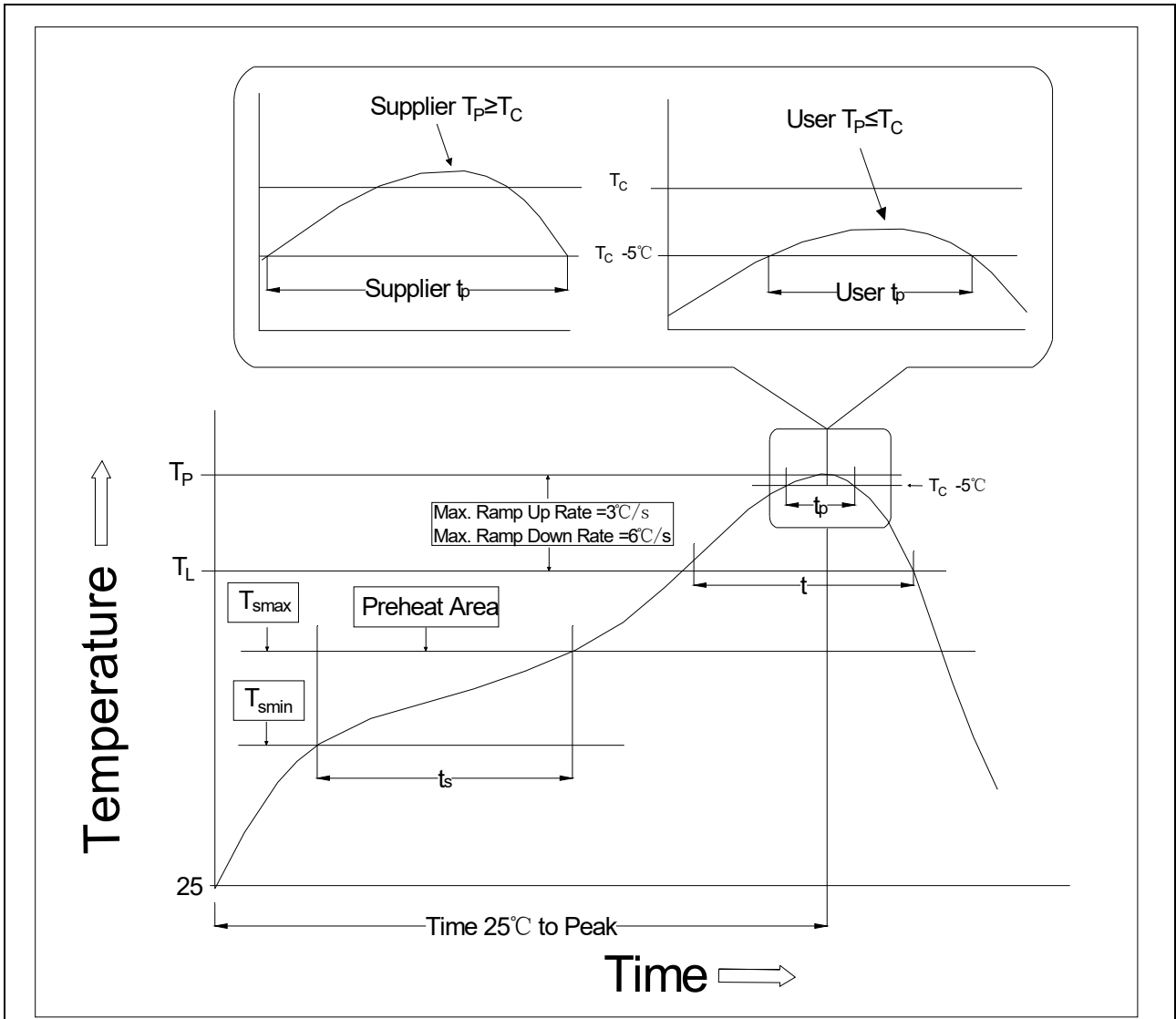

Profile Feature	Sn-Pb Assembly Profile	Pb-Free Assembly Profile
Temperature Min. (T _{smin})	100°C	150°C
Temperature Max. (T _{smax})	150°C	200°C
Time (t _s) from (T _{smin} to T _{smax})	60-120 seconds	60-120 seconds
Ramp-up Rate (t _L to t _P)	3°C/second max.	3°C/second max.
Liquidus Temperature (T _L)	183°C	217°C
Time (t _L) Maintained Above (T _L)	60-150 seconds	60-150 seconds
Peak Body Package Temperature	235°C+0°C/-5°C	260°C+0°C/-5°C
Time (t _P) within 5°C of 260°C	10 seconds	10 seconds
Ramp-down Rate (T _P to T _L)	3-6°C/second	3-6°C/second
Time 25°C to Peak Temperature	6 minutes max.	8 minutes max.

Note:

1. Reflow soldering is recommended at the temperatures and times shown, no more than three times.
2. Avoid direct contact between the epoxy body and any tools or surfaces exceeding its maximum storage temperature.
3. Application of pressure on the epoxy body is prohibited at elevated temperatures. In specific scenarios, any applied force must not exceed 2.5N.
4. Ensure the component has cooled to ambient temperature before proceeding with any subsequent manufacturing steps.
5. The component has a shelf life of one year when stored under standard conditions.
6. Recommend storage Temp.: 0~40°C;
Recommend storage humidity: <60%;
MSL level: MSL 1

Information furnished in this document is believed to be accurate and reliable. However, Jiangsu JieJie Microelectronics Co., Ltd. assumes no responsibility for the consequences of use without consideration for such information nor use beyond it. Information mentioned in this document is subject to change without notice, apart from that when an agreement is signed, Jiangsu JieJie complies with the agreement.

Products and information provided in this document have no infringement of patents. Jiangsu JieJie assumes no responsibility for any infringement of other rights of third parties which may result from the use of such products and information. This document supersedes and replaces all information previously supplied.

 is a registered trademark of Jiangsu JieJie Microelectronics Co., Ltd.

Copyright © 2026 Jiangsu JieJie Microelectronics Co., Ltd. All rights reserved.